

IRD5

Dehydrator Manual User Guide





English



INFORMATION



Congratulations.

And thank you for your purchase. You are about to experience the simplest, healthiest, and most efficient way to dehydrate food. This user's guide is your source for understanding important safety information, product features and modes, recommended dehydration times, cleaning tips, and more. Please read all safety instructions, tips, and warnings found in this guide, before operation.

Before use, wash all trays and crumb tray.

According to the Food and Drug Administration (FDA), the nutrient conservation rates by food's process methods are as follows.

- Dehydrated: 96%
- Canned Food: 20-30%
- Frozen Food: 40-60%

You can easily dehydrate fresh fruits, vegetables, meat and many more with CI's Food Dehydrator and enjoy the taste and nutrients for a longer period.

**DO NOT IMMERSE
APPLIANCE INTO WATER
OR ANY OTHER LIQUID.**

INFORMATION

If you have any further inquiries,
please contact us

ADDRESS

21, Yangpyeong-ro, 12-gil,
Yeongdeungpo-gu, Seoul, Korea
150-810

TEL +82-2-2061-1344

WEBSITE

www.counterintelligence.co.kr

E-MAIL [counterintell@](mailto:counterintell@counterintelligence.co.kr)

counterintelligence.co.kr

IMPORTANT SAFEGUARDS

When using electrical appliances, basic safety precautions should always be followed including the following:

- ① Read all instructions.
- ② Do not touch hot surfaces. Use handles or knobs.
- ③ To protect against electrical shock, do not immerse cord, plugs, or the base in water or other liquids.
- ④ Close supervision is necessary when any appliance is used by or near children.
- ⑤ Unplug from outlet when not in use and before cleaning. Allow to cool before putting on or taking off parts.
- ⑥ Do not operate the appliance with a damaged cord or plug or after the appliance malfunctions or has been damaged in any manner. Return the appliance to the nearest authorized service facility for examination, repair, or adjustment.
- ⑦ The use of accessory attachments is not recommended by the appliance manufacturer may cause injuries.
- ⑧ Do not use outdoors.
- ⑨ Do not let the cord hang over the edge of tables, counters and keep it away from hot surfaces.
- ⑩ Do not place on or near a hot gas or electric burner or in a heated oven.

⑪ Extreme caution must be used when moving an appliance containing hot oil or other hot liquids.

⑫ Always attach plug to appliance first, then plug cord into the wall outlet. To disconnect, turn the machine “off”, then remove plug from wall outlet.

⑬ Do not use appliance for other than intended use.

⑭ Save these instructions and keep them in convenient and dry place.

Household Use Only

Do not immerse in liquids.

If the supply cord is damaged, it must be replaced by the manufacturer, its service agent or similarly qualified persons in order to avoid a hazard.

This appliance can be used by children aged from 8 years and above and persons with reduced physical, sensory or mental capabilities or lack of experience and knowledge if they have been given supervision or instruction concerning use of the appliance in a safe way and understand the hazards involved. Children shall not play with the appliance. Cleaning and user maintenance shall not be done by children unless they are older than 8 and supervised. Keep the appliance and its cord out of reach from children less than 8 years.

WARNING



Make sure the wet areas of your ingredients (especially those with salt) are mostly vaporized before using the dehydrator. Water flowing to the dehydrator could cause electrical shock and fire. Excessive ingredients could decrease the performance of the dehydrator and cause failure of the product. Do not overload the trays.

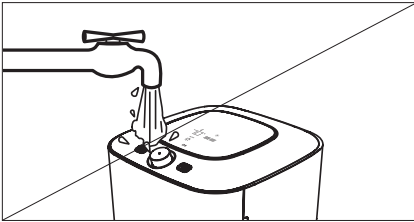

Do not immerse the appliance in water or any other liquid. Do not use the appliance in a humid atmosphere as it could cause fire, electrical shock and failure of the appliance.

Do not use voltage converters.

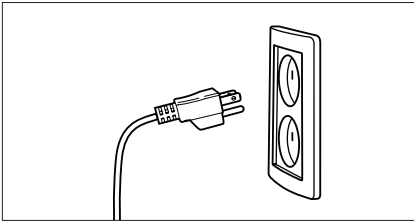

Use the correct voltage and plug for the electrical outlet. Incorrect voltage could cause malfunction and fire. Do not run parallel with other appliance as it could cause fire and electric shock.

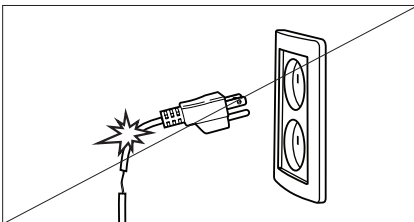

Do not use a damaged power plug. Make sure the plug is free of damage, as it could cause fire. If there is any damage, discontinue use of the dehydrator and contact the nearest customer service.

By not following the instructions, it could cause serious injury or accidents caused by negligence.

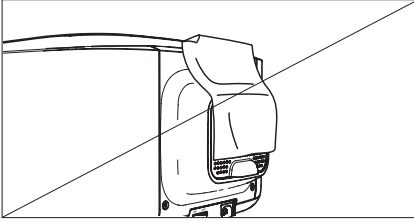

Do not operate if the air inlet is blocked. The inlet should be free of obstruction during use. Blocking the air inlet could cause the alteration of the appliance, fire and malfunction through overheating.

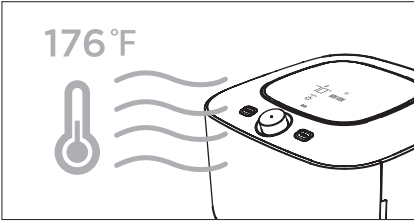

Do not expose the appliance to any environment exceeding 176°F (80°C).

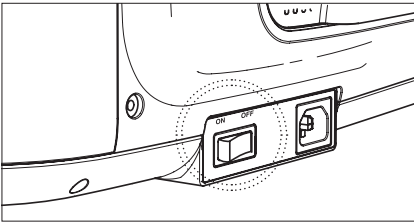

Make sure the power switch is 'OFF' before plugging the appliance.

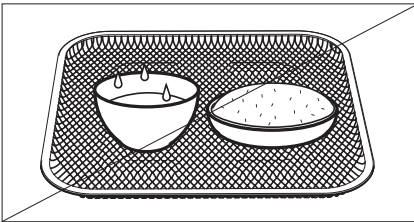

Do not attempt to dehydrate other ingredients or materials that are not recommended.

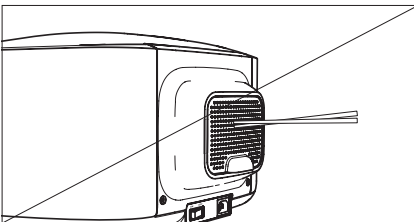

Make sure foreign substances doesn't go into the air inlet. It could cause fire or malfunction.

By not following the instructions, it could cause serious injury or accidents caused by negligence.

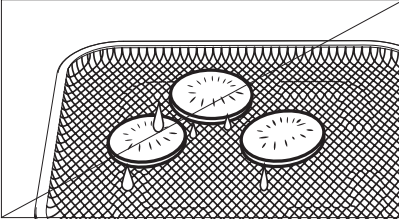

Do not dehydrate wet food.
It could increase the dehydrating time and decrease the output.

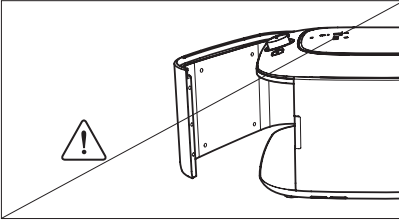

The corner(edge) of the door is sharp and could cause injury to the user by negligence or misuse.

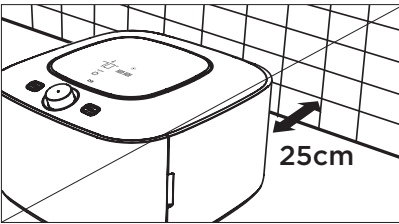

While in use, this product should be in a well ventilated place and at least 25cm away from any walls. By not following instructions, may cause performance degradation, fire electrical shock and abnormal operation.

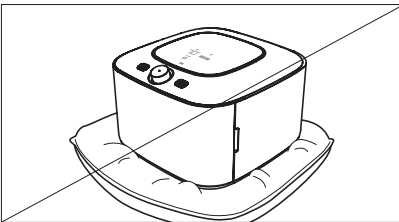

Place the product on a flat, even, hard surface. Do not operate on carpet, cushion, mat or wood floor. It could cause fire and malfunction.

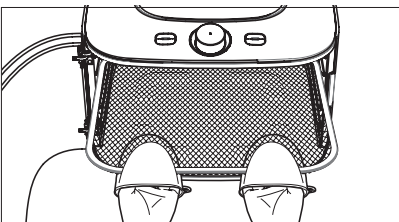

When operating your dehydrator, use the Silicon Gloves to remove trays. Do not handle the trays without gloves, as the inside of the unit and the trays are very hot.

By not following the instructions, it could cause serious injury or accidents caused by negligence.

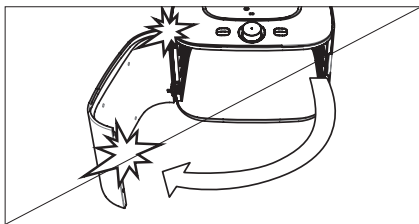

Place the product at a flat, even, hard surface. Do not operate on carpet, cushion, mat or wood floor. It could cause fire and malfunction.

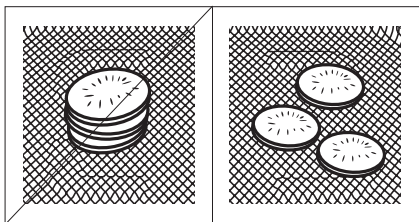

Load the ingredients separately instead of stacking. Stacking your ingredients will not allow for efficient dehydration.

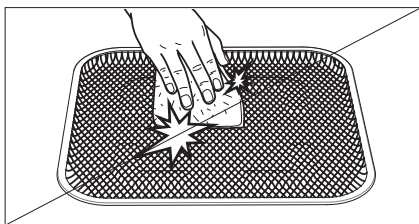

When cleaning the trays, do not use abrasive cleaners. Using such cleaners could damage the surface and cause it to rust.

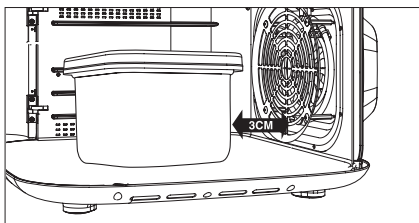

All trays could be removed for producing yogurt or other fermentation with a big container.

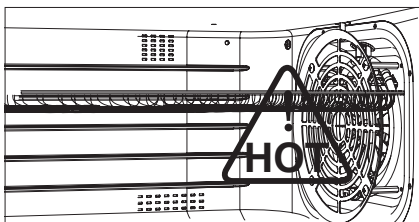

Never attempt to touch the inside of the dehydrator or alter ingredients while it is in operation. It could cause burn, electrical shock or other serious injuries.

By not following the instructions, it could cause serious injury or accidents caused by negligence.

FEATURES of IR D5



For household use only

Air Filter

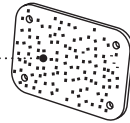

Door

Door handle

Body

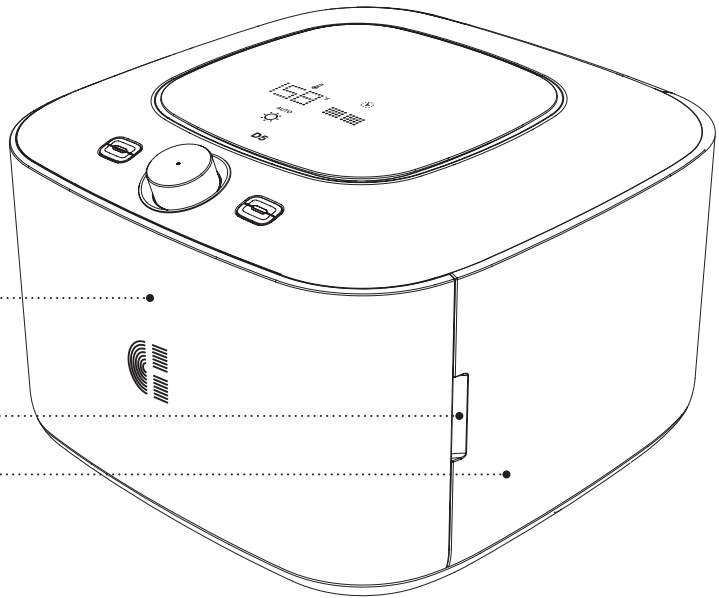

Model	Body Color	Tray material	Trays	Air Filter	ETC.
IR D5	Black & White	Stainless Steel	5 pcs	1 set	Crumb tray 1 pc 1 set of silicon gloves (2pcs)

This product is for household appliance, handle with care.

FEATURES

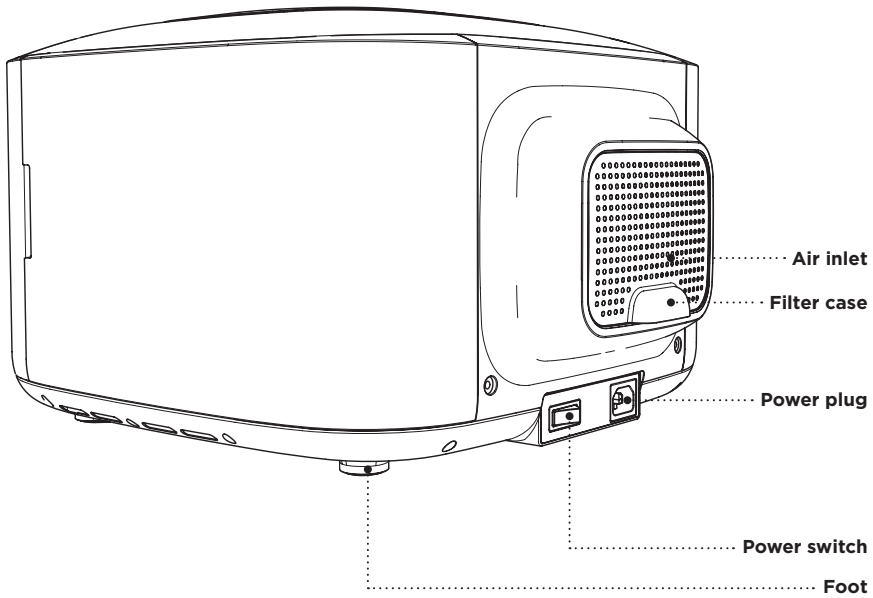

1

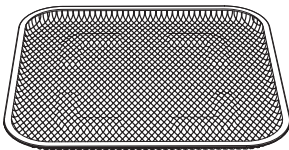

Stainless Steel Tray (STS Tray)

Tray made with stainless steel to load ingredients.

2

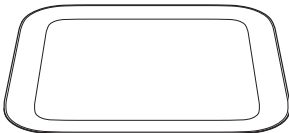

Crumb Tray

This tray catches crumbs or small pieces that may fall to the bottom while loading or removing trays.

All additional accessories are optional.

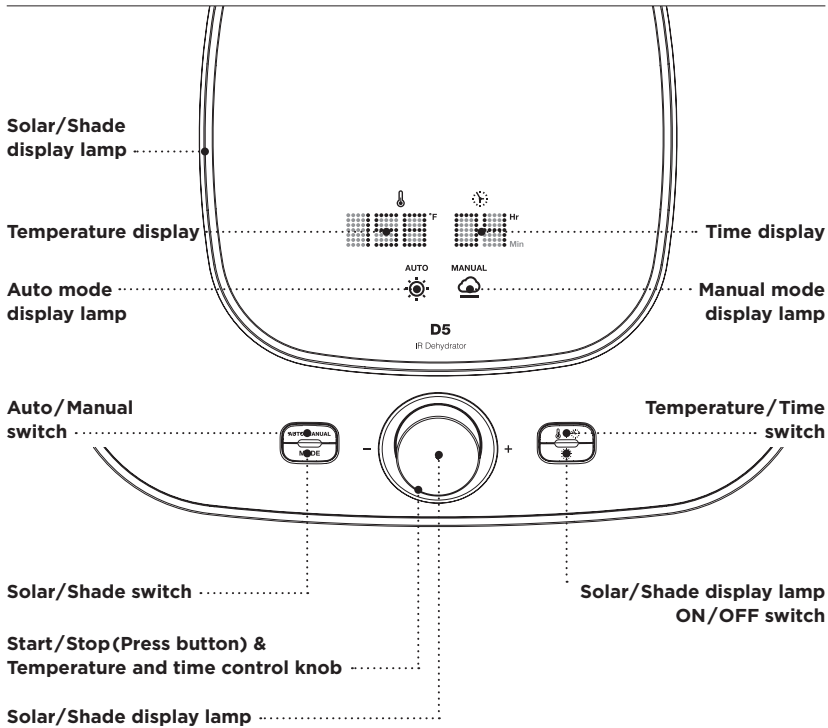

3



Silicon Gloves

These included gloves are for removing hot trays from your dehydrator. They are protective, but thin enough to be flexible. Always wear protective gloves when handling trays or any surfaces that may be hot.

4

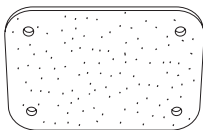

Air Filter

Prevents air pollutants, dirt small debris from flowing into your dehydrator.

Please follow the Operation Method before using the appliance.

OPERATING METHOD

- The IR D5 functions in two primary methods of control : Auto or Manual mode.
- Manual mode allows you to control time and temperature (example : 13 hrs. at 110°F).
- Auto mode helps take some of the guess work out of dehydrating by utilizing moisture detection sensors to regulate time and temperature to efficiently dehydrate your food and stop when the optimal level of dehydration has been reached.
- **Operation**
- Turn on the appliance by pushing the on/off switch, located in the back of the unit, into the 'ON' position.
- The green lamp will be illuminated, temperature & time display will blink, and the center lamp of the control knob and the dry mode icon will be illuminated as well.
- When the door is opened while operation, 'OPEN' will appear on the LED display and stop operating.

Manual Mode

User can set the time and temperature desired through the following steps.

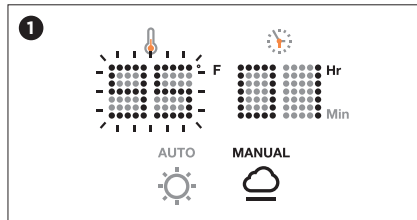

① Turn on the appliance using the switch in the rear. Temperature display will blink and be ready to set the temperature.

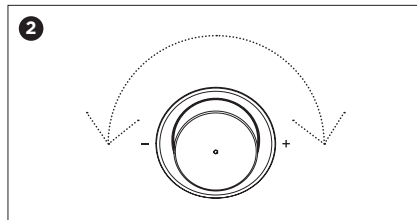

② Temperature & time is adjusted by turning the control knob.

➔ The minimum and maximum temperature range is 35°C to 70°C (86-158°F).

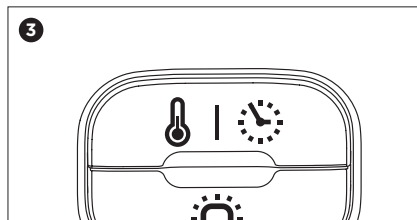

③ Temperature & time switch is used to select the mode from one another. (Temperature & time is changed every time the switch is pressed)

➔ The minimum and maximum time range is 1 to 99 hours.

➔ The timer can be manually disabled to allow for continuous dehydration. To enable continuous dehydration, turn the dial clockwise from 99 hours and the display will show (- -). The unit will stay on until you physically turn it off.

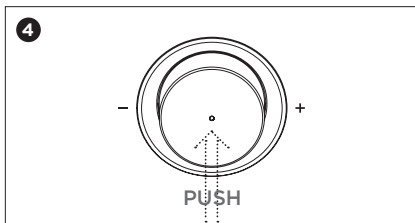

④ Once time and temperature has been selected, simply push the control knob to start dehydration.

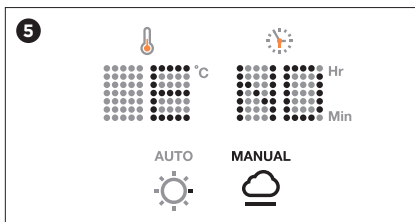

⑤ After the set time runs out, 'END' sign will appear and blink along with a buzzer. The dehydrator will continue to run until cools down to 86°F (35°C).

⑥ To power the unit off, once the dehydration is complete, just push the control knob.

Automatic Mode

The appliance will operate automatically until it reaches a certain humidity.

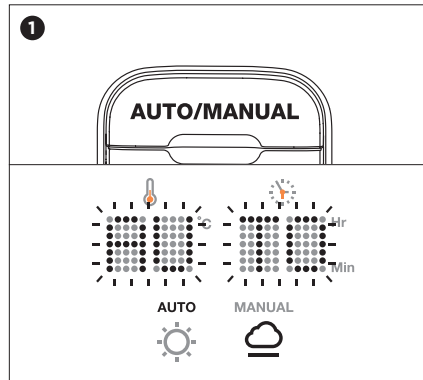

① If you press AUTO/MANUAL switch, the display will show 'AUTO' and blinks.

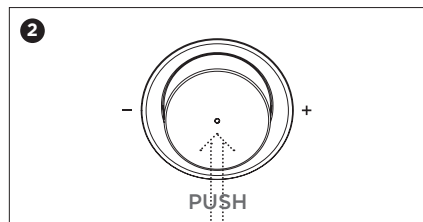

② Without any other settings, push the control knob and it will operate automatically.

In the temperature display will show (- -) and the time display shows how much humidity is remaining. The temperature will rise and fall automatically when using automatic mode.

Solar Mode

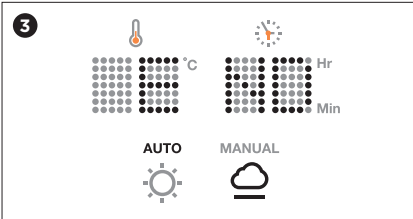

③ After it reaches the certain humidity, 'END' sign will appear and blink along with a buzzer.

➤ If you are not satisfied with the dehydrated state, press AUTO/MANUAL switch, to change it to manual mode and operate with manual drying.

➤ The humidity sensor recognize the relative humidity and will stop operating until the internal humidity reaches under 3%.

'Solar mode' dehydrates your food as if it was dried from sun light.

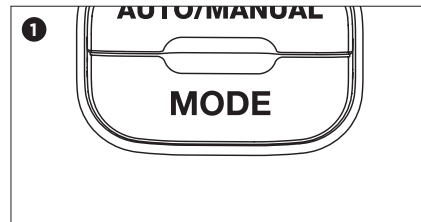

① Press 'MODE' and the lamp will show a yellow light and the sun image will illuminate.

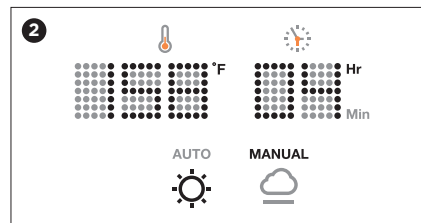

② While the dehydrator is operating, the mode can be changed by simply pressing the MODE button.

Tips for IR D5

It has a front door with stainless steel drawer trays. Therefore, all the trays could be taken out and use all the space for such as fermenting dough and etc. Also by taking out some trays, you will be able to dehydrate ingredients with various heights or sizes.

CLEANING GUIDELINES



TRAYS Including crumb tray

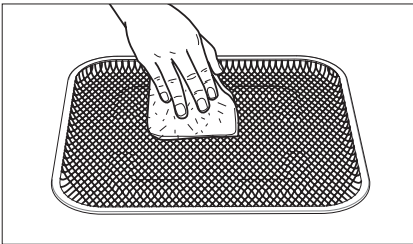

- Your dehydrator trays are easy to clean : simply soak in warm water with a mild detergent for several minutes. A soft-bristle brush will loosen food particles that resist softening by soaking.
- Don't clean any parts with scouring pads, abrasive cleaners, or sharp utensils, as they tend to damage the surface. Trays/base can be washed on the top rack of you dishwasher if you remove them before the drying cycle.

APPLIANCE

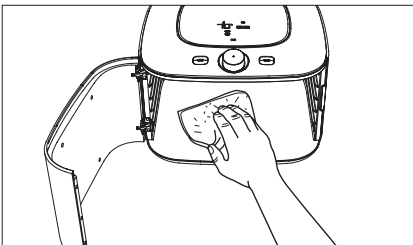

- Use a damp soft cloth or towel to remove any dried food residue from the bottom of the unit. Avoid dripping any water or other liquid into electrical parts.

BE SURE POWER HEAD UNIT IS UNPLUGGED BEFORE CLEANING.

DO NOT IMMERSE POWER UNIT IN WATER OR OTHER LIQUIDS!

DO NOT REMOVE ANY PARTS FROM THE POWER HEAD UNIT!

SERVICE

- Should you experience any problems with your dehydrator, please call Customer Service Center.

PREPARATION



PREPARATION

Load your sliced fruit or vegetable onto the trays. All frozen products must be defrosted before dehydration.

- **Containers**

Use the yogurt cup for yogurt, puree and all other fermentable items.

- **Dehydration Time**

Please refer to 'Dehydrating Guidelines'.

There may be a difference in required dehydration time due to the thickness, sugar, moisture, environment, etc. On average, you can assume that Vegetables takes 4-6 hours, fruits take 10-14 hours, fish and meats take approximately 4 hours at 70 °C (158°F).

REFERENCES

There is a air inlet in the rear of the appliance. Cold air may come out but it is not a malfunction. There are two air outlets on the side of the appliance.

- **Air Filter**

The filter placed at the back prevents foreign substances from flowing into the appliance. Depending on the user environment, the filter needs to be replaced periodically as it could block the air and decrease the performance.(We recommend replacement when the appliance is used 10hours every day for 3months)

- Water drops inside the appliance is natural as it evaporates the moisture from the ingredient.

CAUSE 1 Too much content in the appliance.

CAUSE 2 Too much moisture content in the ingredient.

It is not a malfunction if there is water droplets inside the appliance. It could be reduced if the dehydration time is increased and a more moderate amount of ingredients are dehydrated. Please wipe off the water drops with a soft cloth after use.

DEHYDRATING GUIDELINES



Many variables can contribute to a large difference in drying time.

FRUIT

Dry fruit at 55-60°C (130-140°F). Use average times only as general guideline.

FRUIT	PREPARATION	AVG. DRY TIME (HRS)	TEST FOR DRYNESS
Apples	Peel if desired. Core. Cut slices, rings or chop into pieces	5-7	Leathery, no moisture when cut
Apricots	Do not peel. Halve and pit. Turn inside out or cut slices	10-12	Leathery, pliable
Bananas	Peel. Cut into slices 1/8"-1/4"	8-10	Leathery, slightly sticky in the center, brittle
Firm Skin Berries	(Blueberries, cranberries, etc) Sort. Poke skin or place in boiling water for 1-2min. Blot dry	13-15	Hard
Uneven Drying	Leave whole	13-15	Hard
Cantaloupe	Cut in half. Remove seeds and peel. Cut slices. Blot dry on paper towel	15-17	Leathery, suede-like
Cherries	Wash, pit and remove stems. Poke skin or place in boiling water for 1-2min. Blot dry.	22-24	
Citrus Fruit	Peel, if desired. Cut into slices	8-10	Hard
Coconut	Remove outer skin. Slice	13-14	
Cranberries	Wash. Remove stems. Place in boiling water for 1-2min. Blot dry	17-19	
Grapes	Cut in half. Remove seeds. Place cut side up. Seedless green are better than red or black. Poke skin or place in boiling water 1-2min. Blot dry	22-24	Raisin-like texture
Kiwi	Peel. Cut into slices. Slice 1/4"-3/8" thick.	14-16	
Mangos	Remove skin and slice	14-16	
Melons	Remove skin and seeds. Use deepest tray for water melon. Cut in slices as thick as expander tray size will allow	13-15	
Peaches	Peel, if desired. For easy peeling, dip in boiling water until skin cracks. Cut in half. Pit. Cut in slices	10-12	Leathery, may be slightly sticky in center
Pears	Wash. Peel if desired. Core. Cut in slices or rings	10-12	Leathery, no moisture when cut
Pineapple	Remove crown, skin&eyes. Cut in half. Cut in slices, leaving core in or remove, dice or chop and use Net	8-10	Pliable, still slightly sticky. No visible signs of moisture
Plums	Do not peel. Cut in half. Pit. Turn inside out or cut in slices	10-12	Leathery, pliable
Rhubarb	Trim. Wash. Slice diagonally into 3/4"pieces. Steam 3-4min. Use Net.	8-10	Brittle
Strawberries	Wash. Cut in half. Place cut side up	8-10	Hard, brittle

MEATS, FISH AND POULTRY

Meats and fish should be dried on the highest temperature setting of your dehydrator.

MEATS	CUTS TO SELECT	PREPARATION	TEST FOR DRYNESS
Beef	Lean cuts: Round, Rump, Flank	Cook as for pot roast, until tender. Chill. Remove all fat. Cut into cubes or strips. Season, if desired.	Brittle
Chicken or Turkey	White Meat	Cook by steaming or roasting. Chill. Remove fat and hard skin. Cut or break into pieces or cubes 1/2" thick, 2" long. Season if desired.	Hard
Fish	Lean Fish: Bass, haddock, pike, snapper, halibut, cod, perch, flounder, sole, whiting	Clean fish by removing head, skin and any bones. Steam fish without adding butter. Cool. Break into pieces about 2" square, not thicker than 1/2". Must not contain bones or skins. May be sprinkled with paprika, salt, pepper, onion and garlic powder or other spices before drying.	Brittle

HERB

Dry herbs at 35-41°C (95-105°F). Use average times only as general guideline.

HERB	PART OF PLANT TO DEHYDRATE	PART OF PLANT TO DEHYDRATE
Basil	Leaves	2-3
Chili Peppers	Pods	8-10
Chives	Leaves (Chop)	2-3
Cilantro	Leaves	6-8
Cumin	Trim outer leaves. Cut in half. Core. Cut into strips or dry whole leaves. Blanch/steam.	6-8
Dill	Remove tops and stringy end. Peel, cut crosswise, lengthwise or diagonally into slices, cubes or grate. Blanch/steam.	8-10
Fennel	Cut off woody base. Separate into small flowerets, slice or cube into pieces. Blanch/steam.	10-12
Garlic	Cloves (Break bulbs into cloves. Remove outer peel of each clove)	35
Ginger	Root and leaves	13
Mint	Leaves	13
Oregano	Leaves	13
Parsley	Leaves and stems	13
Rosemary	Leaves	13
Sage	Leaves and stems	13
Tarragon	Leaves	13
Thyme	Leaves	13

VEGETABLES

VEGETABLE	PREPARATION	AVG. DRY TIME(HRS)
Asparagus	Remove woody end. Slice diagonally into 1/2"-1" pieces. Blanch/steam.	6-8
Green Beans	Snip off ends, pull off strings. Dry whole or slice diagonally into 1/2"-1" pieces or cut lengthwise. Blanch/steam.	10-11
Beets	Steam until tender. Cool and peel. Cut in slices, cubes or shoestring strips.	7-9
Broccoli	Cut all stalks in halves or quarters. Blanch/steam.	8-10
Cabbage	Trim outer leaves. Cut in half. Core. Cut into strips or dry whole leaves. Blanch/steam.	8-10
Carrots	Remove tops and stringy end. Peel, cut crosswise, lengthwise or diagonally into slices, cubes or grate. Blanch/steam.	8-10
Cauliflower	Cut off woody base. Separate into small flowerets, slice or cube into pieces. Blanch/steam.	10-12
Celery	Trim. Cut lengthwise or crosswise into strips or pieces. Leaves may also be dried. Blanch/steam.	10-12
Corn	Remove husk and silk. Blanch/steam. Plunge immediately into cold water. When cool, drain. Cut kernels from cob.	10-12
Cucumbers	Peel (skin is bitter when dried). Slice or shred. Salt, if desired.	6-8
Eggplants	Trim. Peel. Cut into round slices, julienne strips or cubes. Blanch/steam. Skin may be dried separately.	6-10
Greens	Cut off stems. Blot dry on paper towels.	6-8
Mushrooms	Remove woody stems. Wipe with brush or cloth. Do not wash. Slice or cube. Small mushrooms may be dried whole.	6-8
Okra	Trim off stem and tip. Slice pods into pieces or cut lengthwise.	6-8
Onions	Cut off stem and root. Remove outer skin cut in slices, rings or dice.	8-10
Peas	Sort. Blanch/steam.	9-11
Peppers	Remove stem and seed head. Cut in rings, strips or dice. Seeds may also be dried. Blanch/steam. For seeds use leather sheets.	8-10
Potatoes	Peel. Remove green lining just under skin. Cut away bruises. Cut into slices, strips or grate. Blanch/steam.	7-9
Pumpkins	Cut in half. Scrape away pulp and seeds. Remove rind. Cut into wedges 1"-3" wide and then into strips "wide. Seeds can also be dried. Blanch/steam.	9-11
Winter Squash (Butternut, Acorn)	Cut in half. Remove seeds and stringy fiber. Peel off rind. Cut into strips or cubes. Seeds may also be dried. Blanch/steam	6-8
Summer Squash (Zucchini)	Peel if desired. Cut in slices, cube, julienne strips or coarsely grate. If larger than 12" remove seeds and fibrous tissue. For vegetable chips soak in soy sauce before drying.	6-8
Tomatoes	Remove stem area. Peel, if desired. Cut in slices. Blot excess moisture before drying	6-8

STORING DRIED FOODS



When food is sufficiently dehydrated, cool thoroughly before storing (approximately 15-30 minutes). If food is allowed to sit too long in the open air, it will begin to absorb moisture. Select appropriate airtight storage containers and store at optimal conditions. If moisture or condensation appears in storage container, food has not completely dried. Return to appliance and continue to dehydrate until completely dry.

LOCATION

- Cool, dark and dry are the keys to maintaining the quality of dried food.
- Glass jars or plastic containers should be placed in a paper bag or in a closed cabinet to keep out light. Cement walls and floors are often damp. Dried food containers should not be placed directly on the floor, or touching a basement or cellar wall.
- Do not store dried food near items with a strong odor, such as varnish, paint remover or kerosene.

CONTAINERS

- Any container that is clean, airtight, and moisture-proof is suitable for storage. Fill each container as much as possible.
- Heavy, zippered plastic bags or heat sealing bags make excellent choices. Filled bags may be placed in metal cans with lids (shortening or coffee cans are good). This will keep out insects and light. Glass jars with tight-fitting lids can be used with or without plastic bags.

- Plastic containers with lids are good, but should be used in conjunction with locking plastic bags, because plastic containers are not airtight.
- Do not use paper or cloth bags, lightweight plastic bags, bread wrappers, unlined metal containers or any container without a tight-fitting lid.

LENGTH OF STORAGE

- In most cases, dried fruits and vegetables should not be stored longer than one year. Plan to use all dried meats, fish, poultry or jerky within a month or two.
- Rotate on a first-dried, first-to-be-used basis. Check dried foods periodically. If the food seems moister than when packed, moisture may be getting into the container. Spread food on drying trays and dry again. Then pack the food in an airtight container.
- Mold indicates that food was not properly dried the first time, or was not properly stored. Discard or compost moldy food. Do not try to use it.

TROUBLESHOOTING GUIDELINES



SYMPTOM	PROBABLE CAUSE	ITEMS TO CHECK
No Heat Motor dead	<ul style="list-style-type: none"> • Switch 'ON'? • LED 'END'? • LED 'OPEN'? • LED blink? 	<ul style="list-style-type: none"> • Plug in the cord again. • Turn the switch to 'ON'. • Check the LED time display. • Make sure the door is closed. • Push the control knob.
Motor OK, No heat	<ul style="list-style-type: none"> • Broken wire or short circuit 	<ul style="list-style-type: none"> • Set the temperature to 70°C (158°F) and operate for 1 hour. Touch the bottom part and find out if there is warmth. • Please find your nearest Customer Service if there is no warmth.
Heat OK Motor dead	<ul style="list-style-type: none"> • Foreign substance between the motor and fan • Liquid flowed into air outlet 	<ul style="list-style-type: none"> • Turn off the switch immediately. • Find out if there is a foreign substance stuck between the motor and fan.
Slow Drying	<ul style="list-style-type: none"> • Tray overloaded. • Air leaks due to warp or improperly placed trays 	<ul style="list-style-type: none"> • Air must flow around food freely for them to dry. Try reducing quantity on each tray. • Find your nearest Customer Service if the motor works too slow. • Replace any warped trays. • Note: The heat from most dishwashers (on the drying cycle) can warp the drying trays. Trays must be hand washed only.
Temperature too low	<ul style="list-style-type: none"> • Unable to control the temperature 	<ul style="list-style-type: none"> • Immediately turn of the appliance and find your nearest Customer Service.
Uneven Drying	<ul style="list-style-type: none"> • Variation in food thickness • Too much food on the trays 	<ul style="list-style-type: none"> • Check whether the foods have uniform thickness. • Check whether any substance is blocking the air flow.
Noisy Fan or Motor	<ul style="list-style-type: none"> • Foreign material in the fan • Motor bearings • Damaged 	<ul style="list-style-type: none"> • Immediately turn of the appliance and find your nearest Customer Service. (Whirling sound of the fan and motor is normal)
ERR 1, ERR 2 ERR 3	<ul style="list-style-type: none"> • Temp sensor error • Internal temp increased to 80°C (176°F). 	<ul style="list-style-type: none"> • Turn off the power and find your nearest CS (Customer Service). • Turn off the power and find your nearest CS.
ERR 4, ERR 5	<ul style="list-style-type: none"> • Humidity sensor error 	<ul style="list-style-type: none"> • Turn off the power and find your nearest CS.
ERR 6-ERR 15	<ul style="list-style-type: none"> • Program error 	<ul style="list-style-type: none"> • Turn off the power and unplug it for 5-10 seconds. Then plug it in and turn it on and it will operate normally.
ERR 17	<ul style="list-style-type: none"> • Fan wires broken 	<ul style="list-style-type: none"> • Turn off the power and find your nearest CS.
ERR 18	<ul style="list-style-type: none"> • Fan defect or wiring overcurrent 	<ul style="list-style-type: none"> • Turn off the power and find your nearest CS.
ERR 19	<ul style="list-style-type: none"> • Fan stopped while operation 	<ul style="list-style-type: none"> • Turn off the power and find your nearest CS.